

Charger ECARR-24-5A

General Characteristics

- 220V to 24V 5A Transformer with saturated nucleus and secondary isolated from the electrical mains.
- Charge by means of 25A Full-Wave Rectifier.
- Automatic disconnection of transformer's primary from electrical mains.
- State bright signs:
- Red → Charging - Green → Charged
- Charge intensity indicator.
- Short circuit protection and polarity inversion internal fuse.
- Choke to recover batteries with level of charge under the manufacturer's advice.
- Earthed chassis, battery's cable and electrical main's plug.

Block Chart

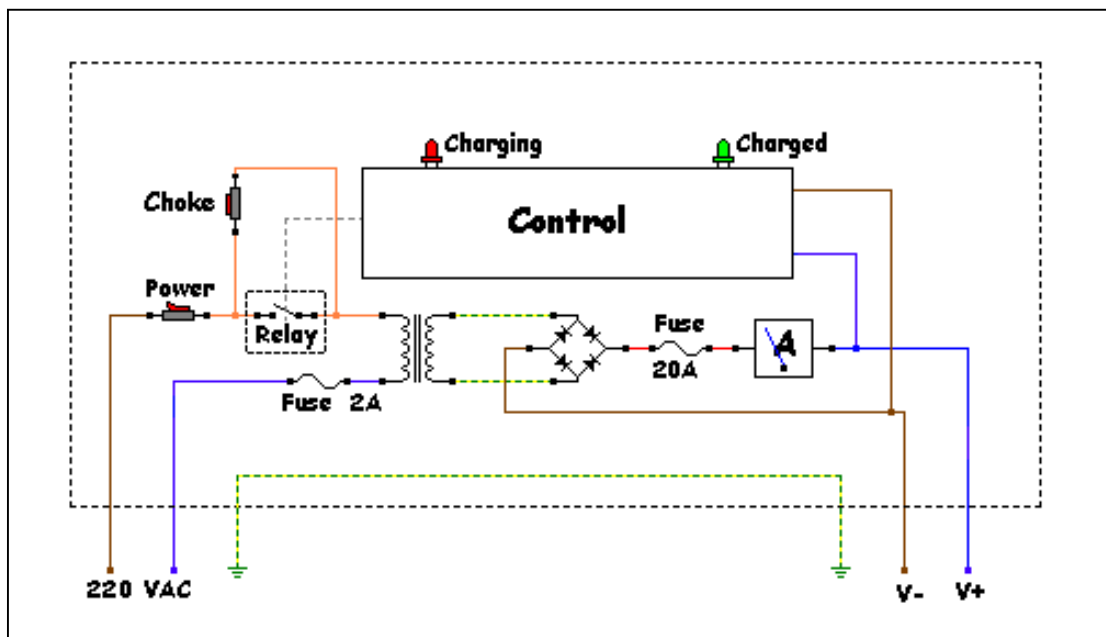

Connection

